

NAVISTAR EXHAUST SYSTEMS



Nationwide toll free 1-866-229-3402

Fax 519-455-1103 • website: www.unitedmuffler.com

NAVISTAR INTERNATIONAL EXHAUST SYSTEMS

2000-UP INTERNATIONAL DT 466 ENGINE WITH LEFT SIDE EXHAUST SYSTEM

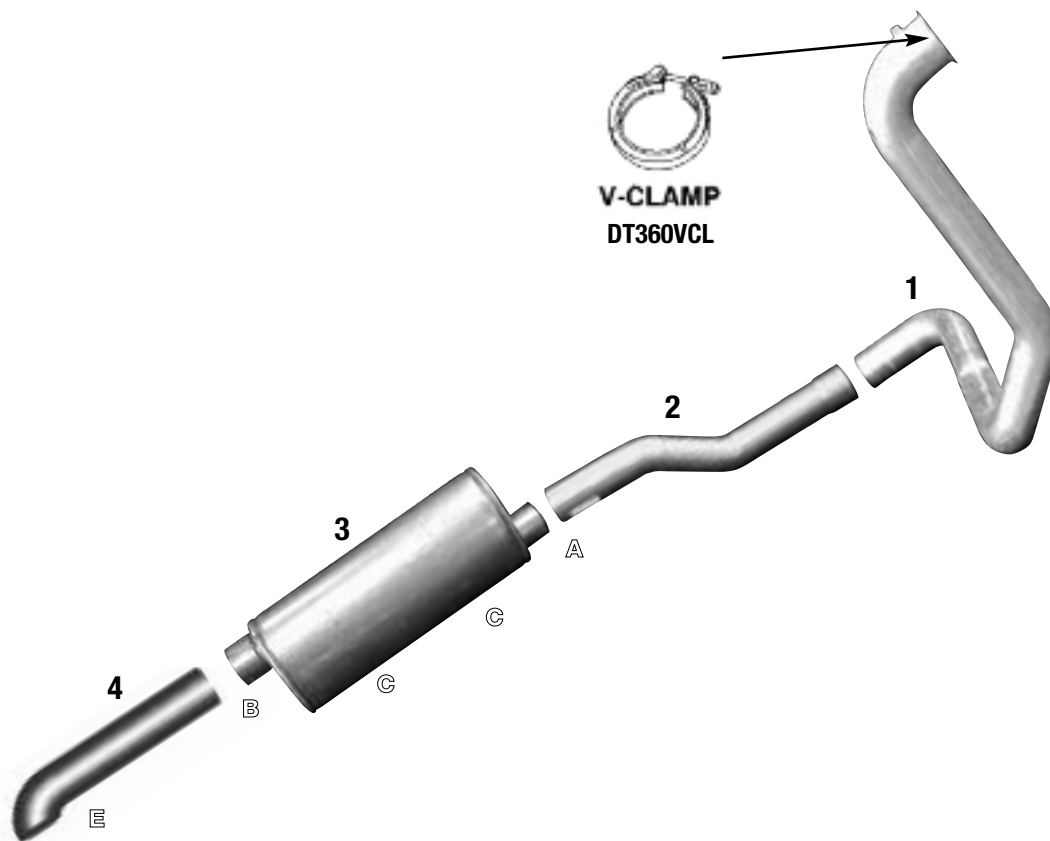

DESCRIPTION	1 TURBO PIPE	2 - TURBO PIPE EXTENSION	3 MUFFLER	4 TURN DOWN
PART #	466DTLE20	NAVEXT20	C-0025	TD400OD

ACCESSORIES



DESCRIPTION	CLAMPS			MUFFLER HANGERS
		A -3-1/2"	B -4"	
PART #	FLAT	350SC	400SC	OVMHIHRE
	PRE-FORMED	350SCPF	400SCPF	
	U-BOLT	U-350	U-400	

UNITED MUFFLER CORP.

U.S. toll free 1-800-247-5391 • Fax 515-224-0727 • website: www.auto-jet.com
 Canada toll free 1-866-229-3402 • Fax 519-455-1103 • website: www.unitedmuffler.com

INTERNATIONAL MEDIUM DUTY TRUCKS

1986-UP NAVISTAR DT466 VERTICAL SYSTEM

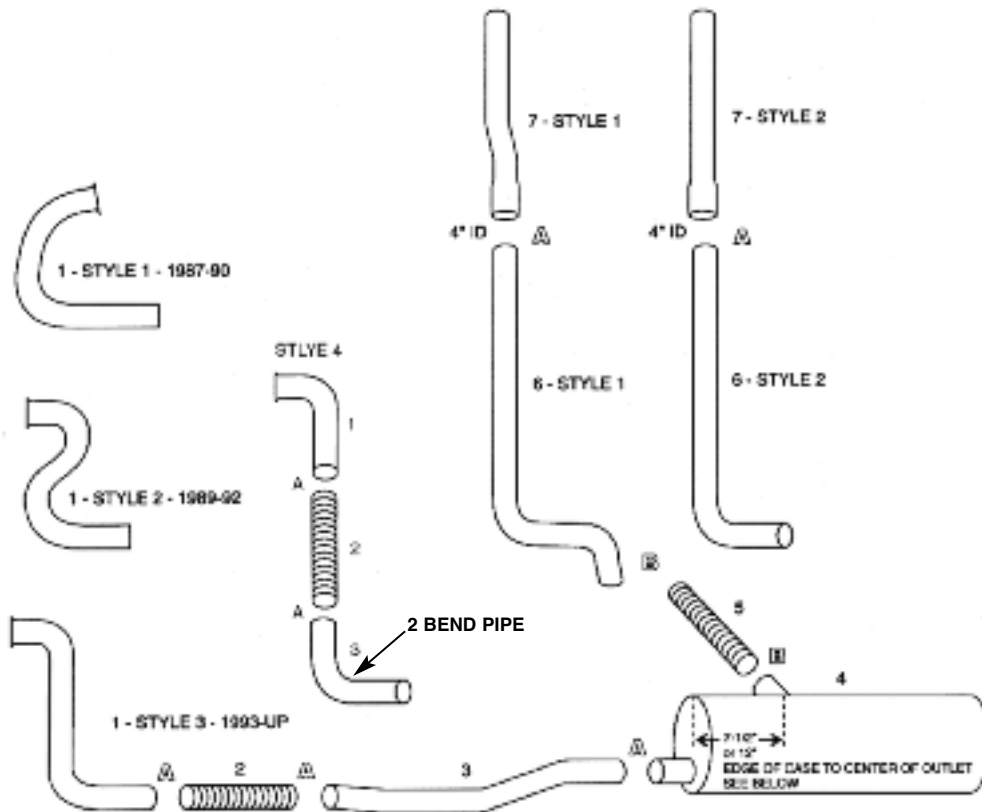

DESCRIPTION	1 TURBO PIPE	2 FLEX	3 - EXHAUST PIPE REAR	4 MUFFLER	5 FLEX	6 - LOWER STACK	7 - UPPER STACK
STYLE 1 PART #	96690L	FLEX35012	96790L	7-1/2" DISTANCE NAV-0005	FLEX40036	NAVSTAK1LO 925047A	NAVSTAK1UP
STYLE 2 PART #	466T89	—	—	12" DISTANCE NAV-0010	—	NAVSTAK2LO	NAVSTAK2UP
STYLE 3 PART #	466T93	—	—	—	—	—	—
STYLE 4 PART #	466TDOT93	—	46693DOTEXT	—	—	—	—

ACCESSORIES

FOR MUFFLER HANGERS
SEE PAGE NAV 9

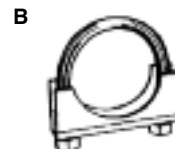

DESCRIPTION	A			CLAMPS		B
PART #	350SCPF	U-350	400SCPF			U-400

UNITED MUFFLER CORP.

U.S. toll free 1-800-247-5391 • Fax 515-224-0727 • website: www.auto-jet.com
Canada toll free 1-866-229-3402 • Fax 519-455-1103 • website: www.unitedmuffler.com

NAVISTAR INTERNATIONAL

1994-UP T444E MODEL 4700 3-1/2" FRONT PIPES

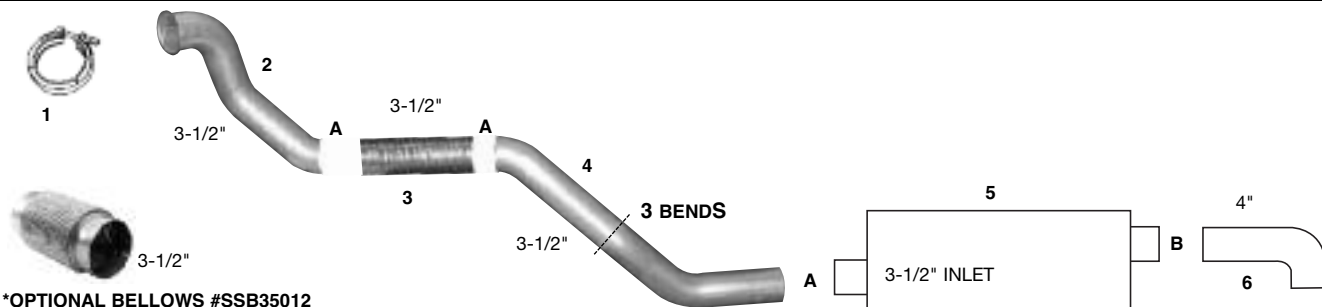

*OPTIONAL BELLOWS #SSB35012

1 - V-CLAMP	2 - TURBO PIPE	3 - FLEX	4 - FLEX TO MUFFLER PIPE	5 - MUFFLER	6 - TURN DOWN
AUTO-JET PART NUMBER					
NAVCL428	T444T35MD	FLEX35012	T444FM35MD	C-0025	TD400
O.E. PART NUMBER					
893944R92	2033702C1	753329C1	2033703C1	C-0025	TD400

1994-UP T444E MODEL 4700 3" FRONT PIPES

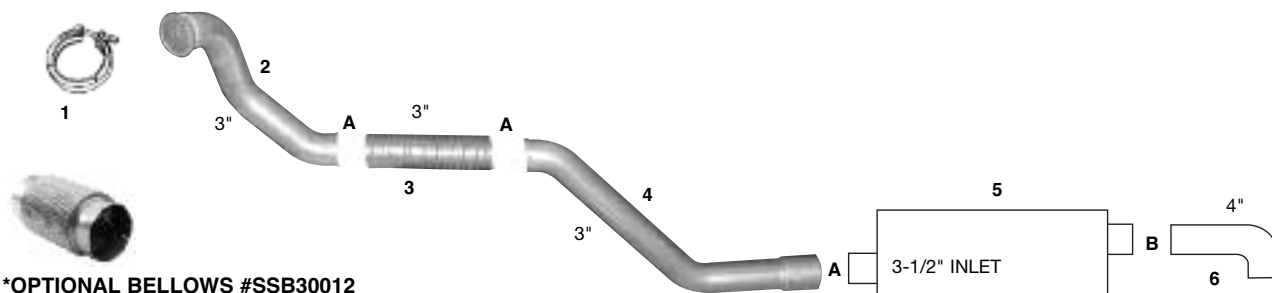

*OPTIONAL BELLOWS #SSB30012

1 - V-CLAMP	2 - TURBO PIPE	3 - FLEX	4 - FLEX TO MUFFLER PIPE	5 - MUFFLER	6 - TURN DOWN
AUTO-JET PART NUMBER					
T444VCL	T444T3MD	FLEX30012	T444FM3MD	C-0025	TD400
O.E. PART NUMBER					
3527500C1	3526527C1	758214C1	1678121C2	C-0025	TD400

ACCESSORIES

CLAMPS



MUFFLER HANGERS
SEE PAGE NAV 9

DESCRIPTION	A - 3-1/2"	B - 4"	C - 3"
FLAT	350SC	400SC	300SC
PRE-FORMED	350SCPF	400SCPF	300SCPF
U-BOLT	U-350	U-400	U-300

UNITED MUFFLER CORP.

U.S. toll free 1-800-247-5391 • Fax 515-224-0727 • website: www.auto-jet.com
Canada toll free 1-866-229-3402 • Fax 519-455-1103 • website: www.unitedmuffler.com

NAVISTAR INTERNATIONAL

1993-UP DT466, RD408 & 5304

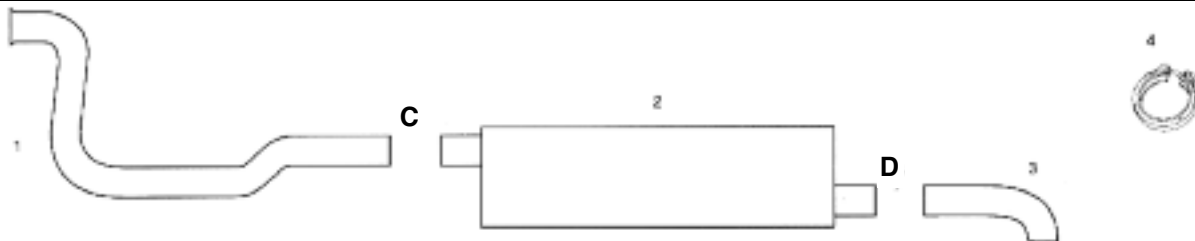

1 - TURBO PIPE	2 - MUFFLER	4 - TURN DOWN	V-CLAMP
466DTURBO93	C-0025	TD400	DT360VCL

1980-UP INTERNATIONAL 9.0 LITRE ENGINE

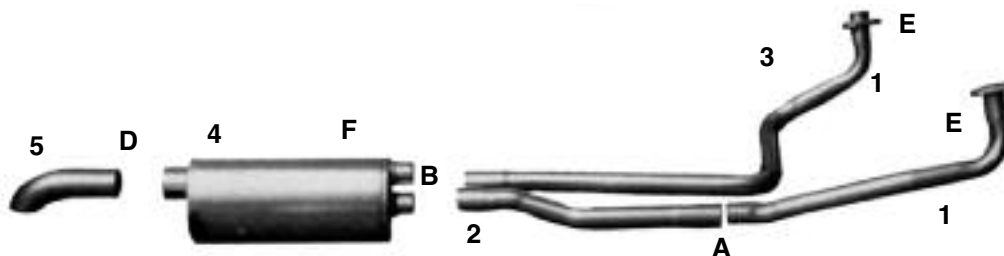

1 - RIGHT MANIFOLD	2 - RIGHT REAR MANIFOLD	3 - LEFT MANIFOLD	4 - MUFFLER	5 - TURN DOWN
482730C1	482726C1	482728C1	C-0040 or 2275400A	TD400

1983-UP INTERNATIONAL 6.9 LITRE, 7.3 LITRE

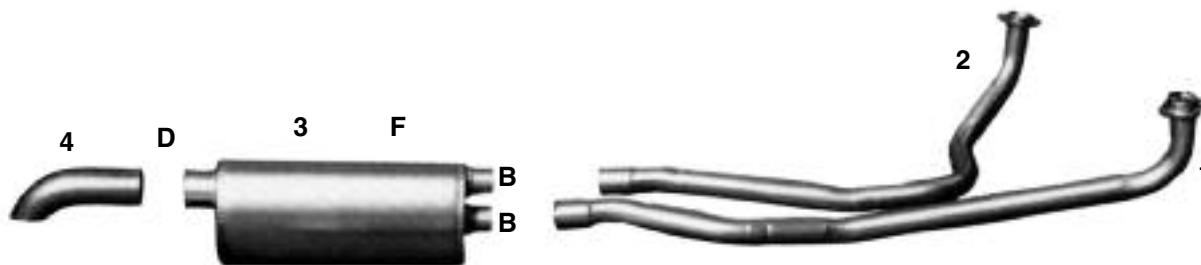

1 - RIGHT MANIFOLD	2 - LEFT MANIFOLD	3 - MUFFLER	4 - TURN DOWN
591595C2	1666966C2	C-0040 or 2275400A	TD400
--	NEW 7.3MPL (1988-UP)	--	--

ACCESSORIES

EXHAUST RING

MUFFLER HANGER

CLAMPS

E



9.0ER

F



OVALMHIH



A(2 1/2")

250SCPF

U-250

B(2 3/4")

275SCPF

U-275

C(3 1/2")

350SCPF

U-350

D(4")

400SCPF

U-400

UNITED MUFFLER CORP.

U.S. toll free 1-800-247-5391 • Fax 515-224-0727 • website: www.auto-jet.com
 Canada toll free 1-866-229-3402 • Fax 519-455-1103 • website: www.unitedmuffler.com

NAV 4

AUTO-JET PART NO.: C-0025
APPLICATION: DIESEL "POPULAR ON TRUCKS & SCHOOL BUSES"
ENGINE: T444E & DT-DTA-360 & 466 C.I.
YEAR: 1988 & UP

3-1/2" INLET -
OFFSET

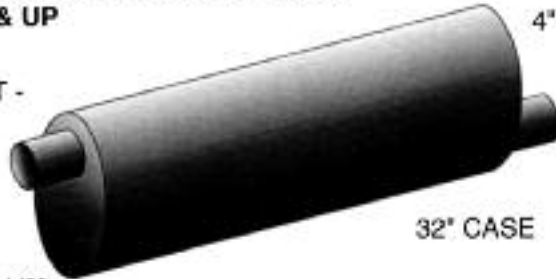

4" OUTLET -
OFFSET

32" CASE

8-1/4 X 11-1/2"
OVAL

AUTO-JET PART NO.: C-0015
APPLICATION: DIESEL
ENGINE: DT-466
YEAR: 1979 TO 1987

3-1/2" INLET -
OFFSET

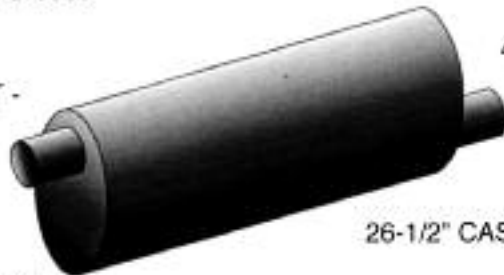

4" OUTLET -
OFFSET

26-1/2" CASE

8-1/4 X 11-1/2"
OVAL

AUTO-JET PART NO.S:
C-0040 - HEAVY DUTY
2-275400A - ECONOMY
APPLICATION: DIESEL "POPULAR ON SCHOOL BUSES"
ENGINE: 9.0 - 7.3 - 6.9 & 3208 CAT.
YEAR: 1980 & UP

DUAL
2-3/4"
INLETS

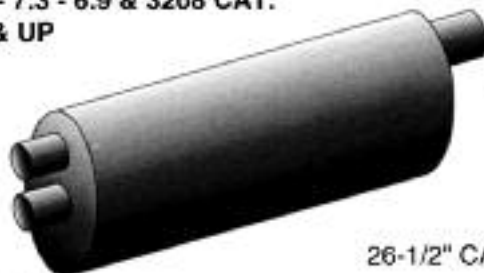

4" OUTLET

26-1/2" CASE

8-1/4 X 11-1/2"
OVAL

POPULAR NAVISTAR MUFFLER HANGERS

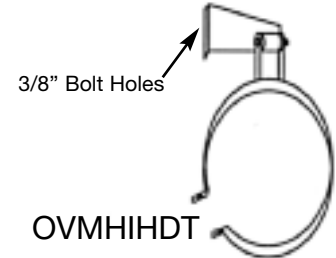

Engines: DT466-DT360-T444
 OE Cross Ref. # 1660540C91

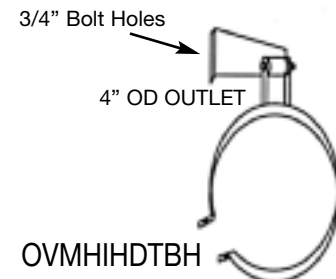

Engines: DT466-DT360-T444
 OE Cross Ref. # 2013206C91



Engines: 7.3-6.9 Litre
 OE Cross Ref. # 1660543C91

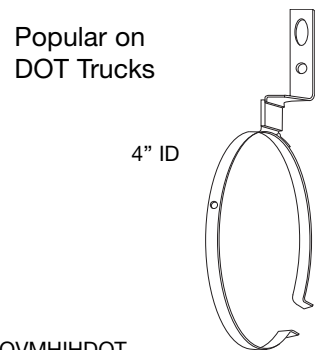

Popular on
DOT Trucks

4" ID

OVMHIHDOT
 OE Cross Ref. # 1661881C96

UNITED MUFFLER CORP.

U.S. toll free 1-800-247-5391 • Fax 515-224-0727 • website: www.auto-jet.com
 Canada toll free 1-866-229-3402 • Fax 519-455-1103 • website: www.unitedmuffler.com

NAVISTAR TRUCK MUFFLERS



END INLET - SIDE OUTLET 8-1/4" X 11-1/2" OVALS

AUTO-JET PART NO.: NAV-0005
SIDE OUTLET
Navistar Part No. OE 1669749C1
1669751C1

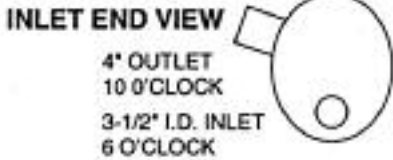

32" CASE
8-1/4 X 11-1/2" OVAL
7" FROM END OF CASE
TO CENTER OF OUTLET

FOR 6" SHORTER CASE
ORDER NAV-0040

POPULAR NAVISTAR MUFFLER HANGERS

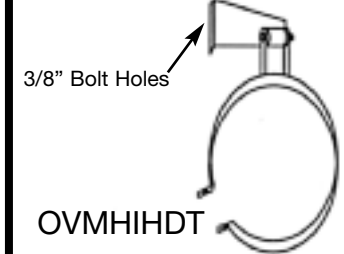

Engines: DT466-DT360-T444
OE Cross Ref. # 1660540C91

AUTO-JET PART NO.: NAV-0010
APPLICATION: DT 360 & DT 466
SIDE OUTLET
Navistar Part No. OE 1647999C1
New Navistar No. 1657433C1

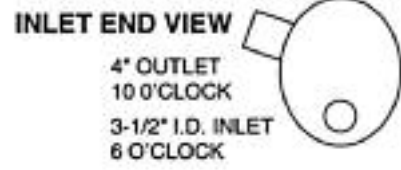

32" CASE
8-1/4 X 11-1/2" OVAL
12" FROM END OF CASE
TO CENTER OF OUTLET

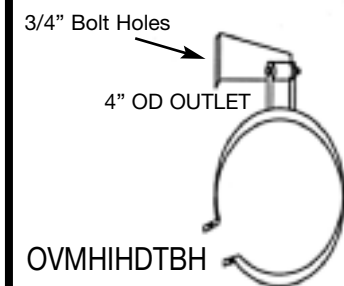

Engines: DT466-DT360-T444
OE Cross Ref. # 2013206C91

AUTO-JET PART NO.: NAV-0015
APPLICATION: DT 360 & DT 466
SIDE OUTLET
Navistar Part No. OE 1648000C1

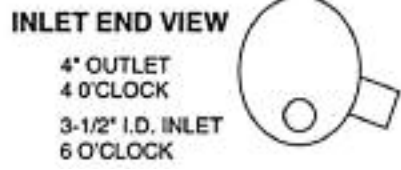

32" CASE
8-1/4 X 11-1/2" OVAL
12" FROM END OF CASE
TO CENTER OF OUTLET

FOR 6" SHORTER CASE
ORDER NAV-0040

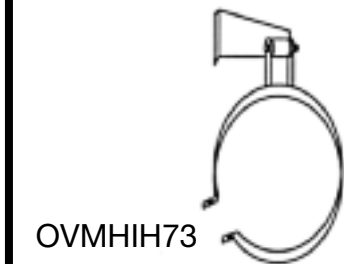

Engines: 7.3-6.9 Litre
OE Cross Ref. # 1660543C91

END INLET AND OUTLET ON SAME END REVERSE FLOW

AUTO-JET PART NO.: NAV-0020
END INLET - END OUTLET
SAME END - REVERSE FLOW

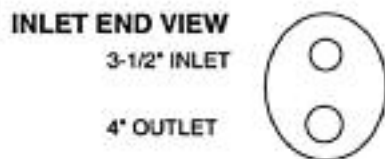

32" CASE
8-1/4 X 11-1/2" OVAL

for 27" case order c-0050

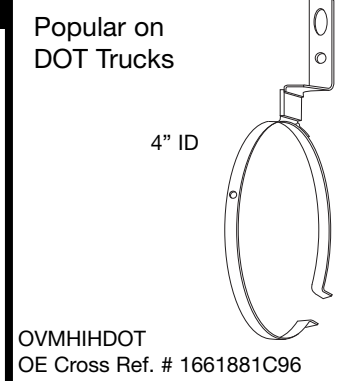

UNITED MUFFLER CORP.

U.S. toll free 1-800-247-5391 • Fax 515-224-0727 • website: www.auto-jet.com
Canada toll free 1-866-229-3402 • Fax 519-455-1103 • website: www.unitedmuffler.com



NAVISTAR EXHAUST COMPONENTS

8-1/4" X 11-1/2" OVALS

AUTO-JET PART NO.: NAV-0025
APPLICATION: DT360 & DT466
ESPECIALLY FOR HIGHWAY DEPT. TRUCKS
5" SHORTER CASE THAN O.E. 1664453C2

For Muffler Hangers
See Page MUFF 10

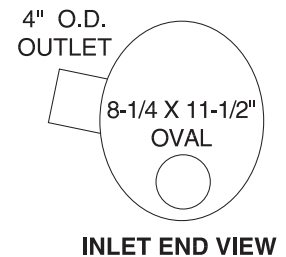
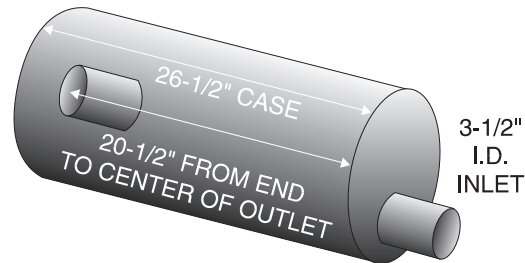

AUTO-JET PART NO.: NAV-0030 HEAVY DUTY MUFFLER
86754M ECONOMY MUFFLER

APPLICATION: DT360 & DT466
 Navistar Part No.: O.E. 1664453C2

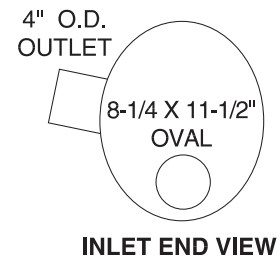
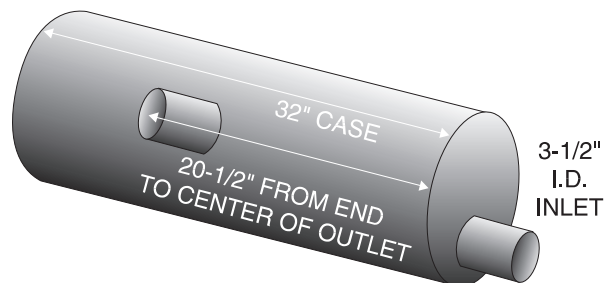

AUTO-JET PART NO.: NAV-0035
END INLET - SIDE OUTLET
NAVISTAR PART NO. 578 070 C1

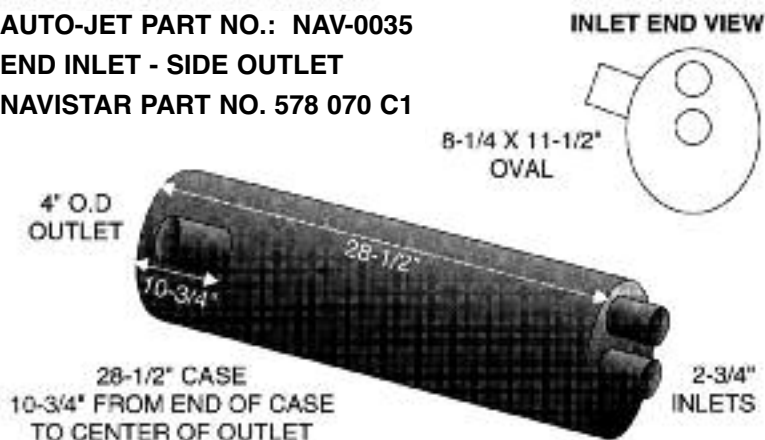

AUTO-JET PART NO.: NAV-0040
6" SHORTER CASE THAN NAV-0005

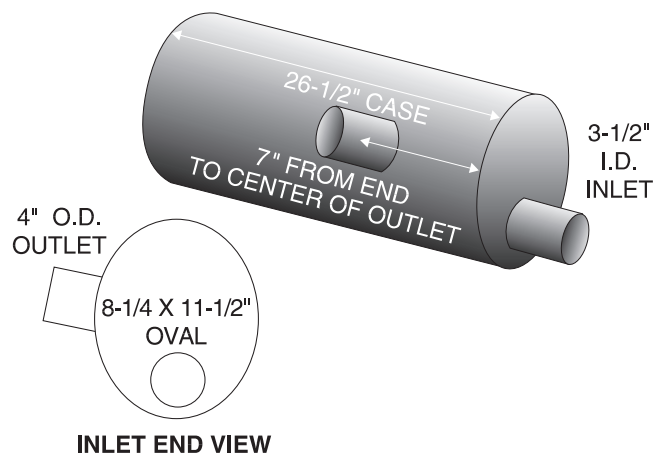

UNITED MUFFLER CORP.

U.S. toll free 1-800-247-5391 • Fax 515-224-0727 • website: www.auto-jet.com
Canada toll free 1-866-229-3402 • Fax 519-455-1103 • website: www.unitedmuffler.com

NAVISTAR

END INLET - END OUTLET

AUTO-JET PART NO.S:
C-0030 - HEAVY DUTY
END INLET - SIDE OUTLET
 Navistar Part No. 508 894 C1
 New Navistar No. 1657433C1

INLET END VIEW

8-1/4 X 11-1/2"
 OVAL



OUTLET END VIEW

4" O.D. OUTLET



8-1/2" X 11-1/2" OVAL

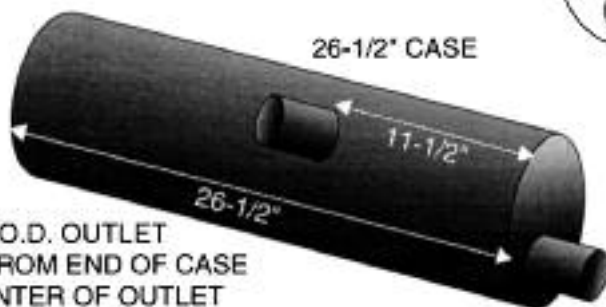

26-1/2" CASE

11-1/2"

4" O.D. OUTLET

11-1/2" FROM END OF CASE
 TO CENTER OF OUTLET

3-1/2"
 INLET

INTERNATIONAL ACCESSORIES



NOTE: International reference numbers are for identification purposes only.

DESCRIPTION	TURN SIGNAL	INGINTION		RESERVOIR - 1/2 GAL. W/ PUMP & CAP	HEADLIGHT
PART #	NAVTSW	NAVIGNSWS	NAVIGNSW	NAVWWR1	NAVHLSW
INT'L REF. #	417302C94	1652306C91	468438C91	394120C91	393442C1
DESCRIPTION	DIMMER SWITCHES			-	RADIATOR SURGE TANK
	3800	S-MODEL	LOADSTAR		
PART #	NAVDIM38	NAVDIMS	NAVDIM	-	NAVSURGE
INT'L REF. #	1661899C91	452187C1	594189C1	-	1619114C5

UNITED MUFFLER CORP.

U.S. toll free 1-800-247-5391 • Fax 515-224-0727 • website: www.auto-jet.com
 Canada toll free 1-866-229-3402 • Fax 519-455-1103 • website: www.unitedmuffler.com

NAV 8

AUTO-JET PART NO.: 85-0040
APPLICATION: GAS
ENGINE: 392 C.I. & 345 C.I.
YEAR: 1979 TO 1987

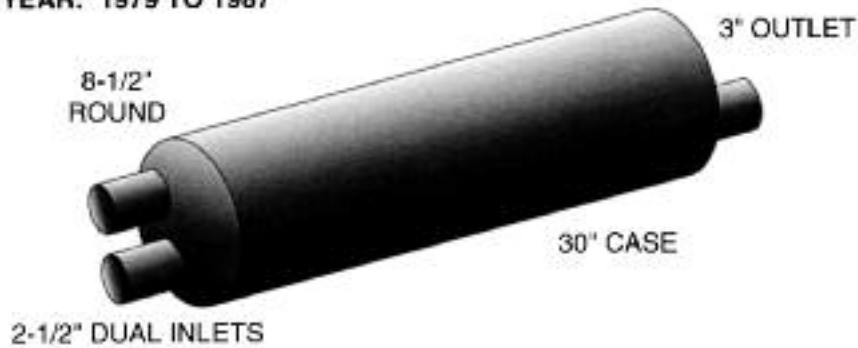

MUFFLER HANGER



#850MH

AUTO-JET PART NO.: 85-0075
APPLICATION: GAS
ENGINE: 404 C.I.
YEAR: 1979 TO 1987

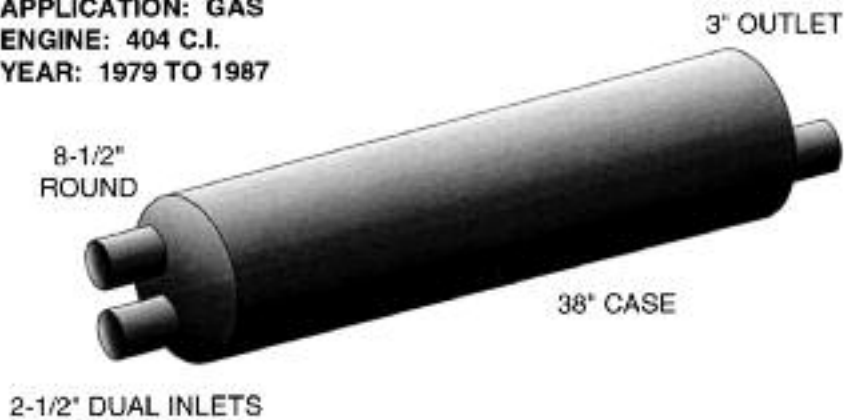

MUFFLER HANGER



#850MH

AUTO-JET PART NO.: 85-0015
APPLICATION: GAS
ENGINE: 404 C.I., 392 C.I., 345 C.I.
YEAR: 1972 TO 1978

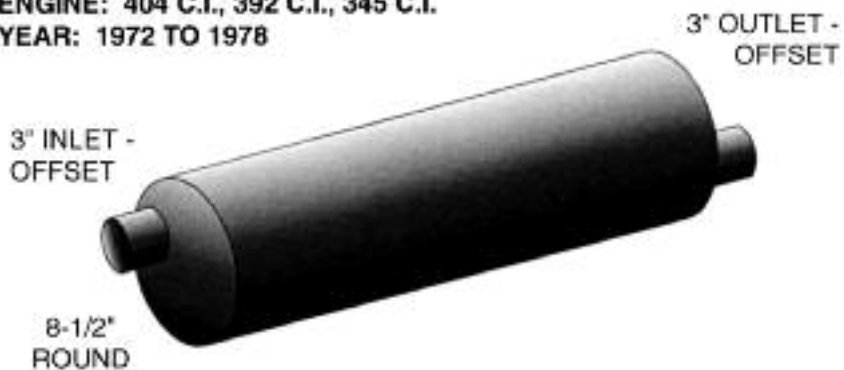

MUFFLER HANGER



#850MH

UNITED MUFFLER CORP.

U.S. toll free 1-800-247-5391 • Fax 515-224-0727 • website: www.auto-jet.com
 Canada toll free 1-866-229-3402 • Fax 519-455-1103 • website: www.unitedmuffler.com

United #	NAVISTAR #
466DTLE20	3554832C1
NAVEXT20	2006821C1
350400L	1647998C1
96690L	587519C2
466T89	1684397C1
466T93	2004504C1
466TDOT93	2005354C1
96790L	587521C2
T444T35MD	2033702C1
FLEX35012	753329C1
T444FM35MD	2033703C1
T444VCL	3527500C1
T444T3MD	3526527C1
FLEX30012	758214C1
T444FM3MD	1678121C2
466DTURBO93	2004557C1
360DT90	1684397C1
360DT90EXT	1686802C1
360DTLE	1616314C1
466DTLE	1621340C1
360DTLEXT	1616315C1
360DTURBO	1668838C1
360DTURBRH	1614955C1
90RMP	482730C1
900RRMP	482726C1
90LMP	482728C1
69MPR	591595C2
73MPL	1666966C2
OVMHIHDT	1660540C91
OVMHIHDTBH	2013206C1
OVMHIH73	1660543C91
OVMHIHDOT	1661881C96
NAV-0005	1669749C1
NAV-0005	1669751C1
NAV-0010	1647999C1

UNITED MUFFLER CORP.

U.S. toll free 1-800-247-5391 • Fax 515-224-0727 • website: www.auto-jet.com
Canada toll free 1-866-229-3402 • Fax 519-455-1103 • website: www.unitedmuffler.com

NAV 10

NAV-0010	1657466C1
NAV-0015	1648000C1
NAV-0030	1664453C2
NAV-0035	578070C1
C-0030	508894C1
C-0030	1657433C1
NAVSURGE	1619114C5

UNITED MUFFLER CORP.

U.S. toll free 1-800-247-5391 • Fax 515-224-0727 • website: www.auto-jet.com
Canada toll free 1-866-229-3402 • Fax 519-455-1103 • website: www.unitedmuffler.com

NAV 11